



Part number
CSHF 10



Brief description:

female insert, 10 poles + PE, Spring connection contacts SQUICH, 16A, 500V, 6kV, 3, silver plated, size "57.27", CLASS insert series

| Product description | |
|---|---|
| Model | female insert |
| Version | SQUICH® Spring connection contacts |
| Series | CSH |
| Product type | with female contacts |
| Family | CLASS inserts |
| Size | size "57.27" |
| N. of poles | 10 poles +  |
| Technical data | |
| Current | 16 A (A.C. and D.C.) |
| Voltage | 500 V |
| Rated impulse withstand voltage | 6kV |
| Pollution degree | 3 |
| Wire cross-section | 0,14 mm ² - 2,50 mm ² |
| AWG size | 26 - 14 |
| Operating temperature range (min, max) | -50°C ... +70°C |
| Contact type | silver plated |
| Mating cycles | ≥ 200 |
| IP degree of protection | IP20 without enclosure; IP65/IP66/IP67/IP68 with enclosure |
| Further technical details | |
| Characteristics according to EN 61984 | 16A 500V 6kV 3; 16A 400/690V 6kV 2 |
| Insulation resistance | ≥ 1 GΩ |
| Rated voltage according to UL/CSA | 600V |
| UL 94 flammability rating | V-0 |
| Weight | 67,00 g |

| Approvals / Standards | |
|----------------------------------|---|
| Reference standard | EN 61984 (2001-11) |
| Quality mark |    EAC |
| Conformity | CQC, CE |
| General ordering information | |
| EAN13 code | 8015747019194 |
| Tariff number | 85369095 |
| Country of origin | Made in EU (IT) |
| ETIM classification | EC000438 |
| Packaging Information | |
| Packaging length | 245,00 mm |
| Packaging height | 165,00 mm |
| Packaging width | 215,00 mm |
| Packaging weight | 2,01 kg |
| Packaging volume | 8,69 dm ³ |
| Packaging description | Carton box |
| Packaging quantity | 30 Pcs |
| Packaging EAN code | 8015747170666 |
| Sub-packaging length | 197,00 mm |
| Sub-packaging height | 44,00 mm |
| Sub-packaging width | 113,00 mm |
| Sub-packaging weight | 0,34 kg |
| Sub-packaging volume | 0,98 dm ³ |
| Sub-packaging description | Carton |
| Sub-packaging quantity | 5 Pcs |
| Sub-packaging EAN barcode | 8015747170673 |

Part number CSHF 10



Catalogue drawings

Catalogue drawings

dimensions in mm

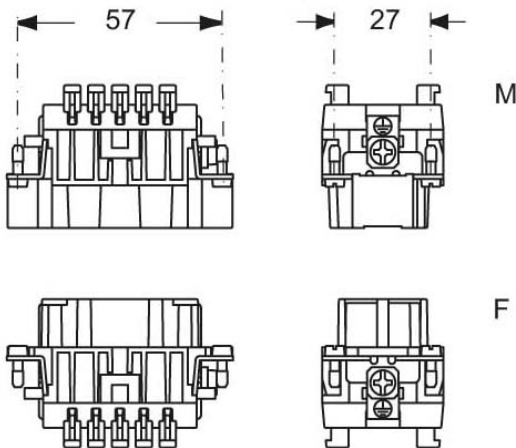

contacts side (front view)

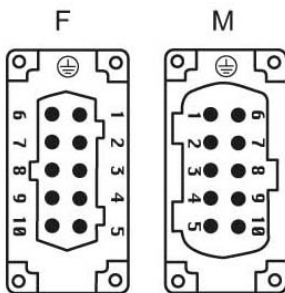
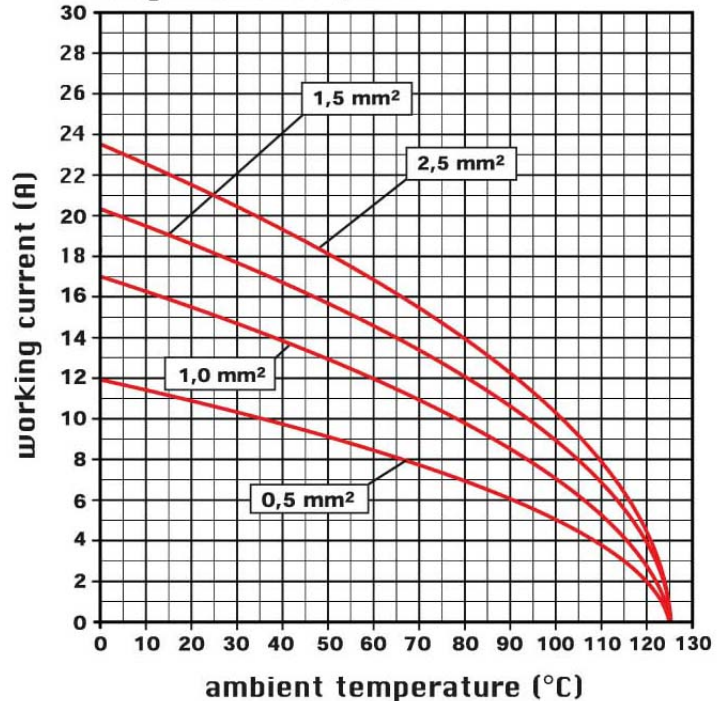

diagram CSH 10 poles



Notes

CSHF/M 10

- characteristics according to EN 61984:

16A 500V 6kV 3

16A 400/690V 6kV 2

- rated voltage according to UL/CSA: 600V

- insulation resistance: > 10 GOhm

- ambient temperature limit: -40 °C ... +125 °C

- are made of self-extinguishing thermoplastic resin UL 94 V0

- mechanical life: > 500 cycles

- contact resistance: < 3 mOhm

- enclosures: size "57.27":

C-TYPE IP65/IP66

C7 IP67 stainless steel lever

V-TYPE IP65/IP66

stainless steel lever

T-TYPE IP65 insulating

JEI zinc-plated steel lever

BIG hoods

W-TYPE aggressive environments

EMC

central lever

IP68

- panel supports:

COB

actuator button connections

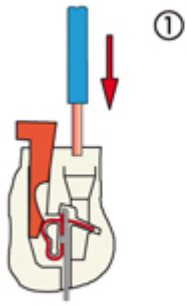

①

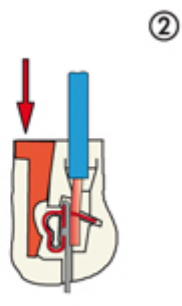

②

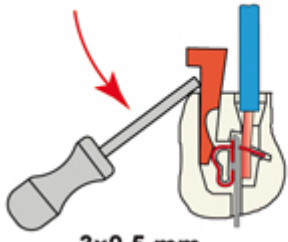

3x0,5 mm

Reopening
